

Ultra low dropout, 800mA, CMOS LDO

Descriptions

The WL2803K series are ultra low dropout, Low quiescent current, high PSRR CMOS LDO. The dropout voltage is 260mV (Typ.) at 800mA load current.

Using CMOS construction, the quiescent current consumed by the WL2803K is typically 150uA over the entire input voltage range, making it attractive for consumer, networking applications that demand high output current.

The WL2803K series are available in wide output voltage range version from 1.2V to 3.3V with 0.1V step. Standard output voltages are 1.8V, 3.3V. Other output voltage options are available upon request.

The WL2803K series offer thermal shutdown (OTP) and current limit functions, to assure the stability of chip and power system at wrong condition, and it uses trimming technique to guarantee output voltage accuracy within ±2%.

The WL2803K regulators are available in SOT-89-5L packages. Standard products are Pb-free and Halogen-free.

Features

- Input voltage : 2.5V~5.5V
- Output voltage : 1.8V, 3.3V (Or upon request)
- Output current : 800mA
- PSRR : 65dB @ 1KHz
- Dropout voltage : 260mV @ I_{OUT}=0.8A
- Output noise : 100uV
- Quiescent current : 150µA Typ.

Applications

- LCD TV
- STB
- Computer, Graphic card
- Network communication equipments
- Others portable electronics devices



SOT-89-5L

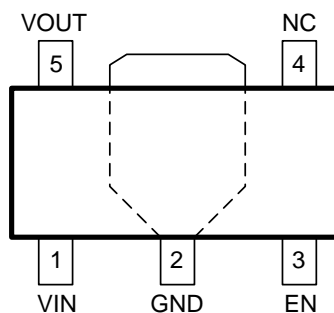

Pin Configuration (Top View)

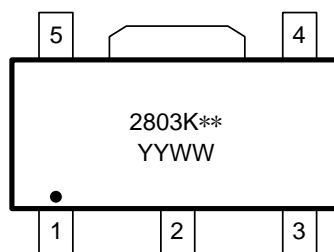

- 2803K = Device code
- ** = Voltage code (33: 3.3V)
- YY = Year code
- WW = Week code

Marking

Order Information

For detail information, Please refer to page 9.

Typical Application

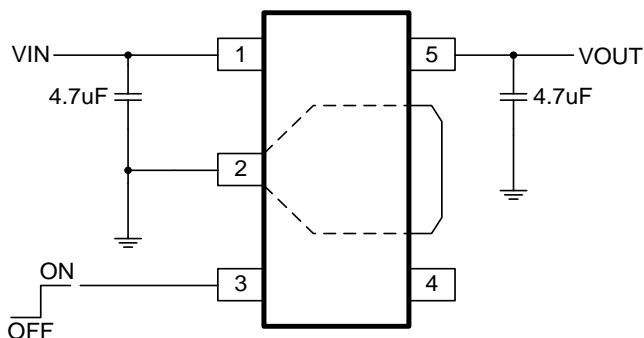

Pin Description

PIN	Symbol	Description
1	VIN	Input
2	GND	Ground
3	EN	Enable, Active High
4	NC	Not Connect
5	VOUT	Output

Block Diagram

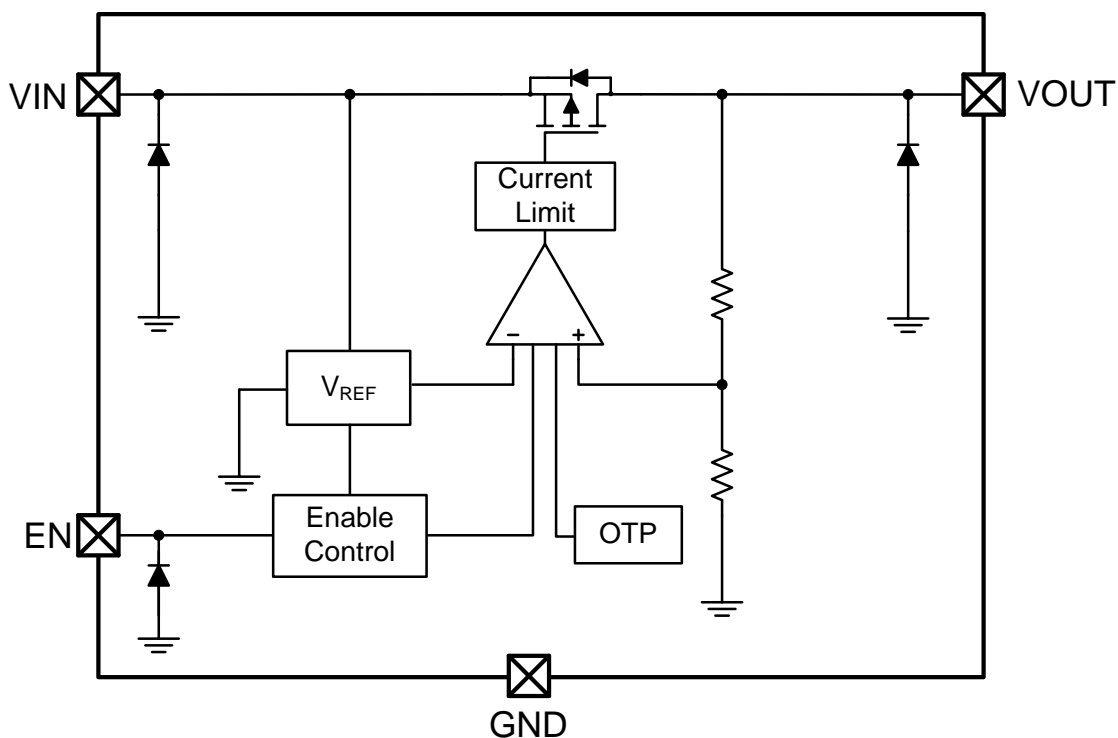

Absolute Maximum Ratings

Parameter	Symbol	Value	Unit
Input voltage range	V_{IN}	-0.3 ~ 6.5	V
Output voltage range	V_{OUT}	-0.3 ~ V_{IN}	V
Power dissipation *1 *3	P_D	1.0	W
Power dissipation *2 *3		0.5	W
Thermal resistance *1	$R_{\theta JA}$	125	°C/W
Thermal resistance *2		250	°C/W
Junction temperature	T_J	150	°C
Lead temperature(10s)	T_L	260	°C
Storage temperature	T_{stg}	-55 ~ 150	°C
ESD Ratings	HBM	±8000	V
	MM	±400	V

Note: These are stress ratings only. Stresses exceeding the range specified under “Absolute Maximum Ratings” may cause substantial damage to the device. Functional operation of this device at other conditions beyond those listed in the specification is not implied and prolonged exposure to extreme conditions may affect device reliability.

*1: Surface mounted on FR-4 Board using 1 square inch pad size, dual side, 1oz copper

*2: Surface mounted on FR-4 board using minimum pad size, 1oz copper

*3: Power dissipation is calculate by $P_D = (V_{IN} - V_{OUT}) \times I_{OUT}$

Recommend Operating Ratings

Parameter	Symbol	Value	Unit
Operating Supply voltage	V_{IN}	2.5 ~ 5.5	V
Operating Temperature Range	T_{opr}	-40 ~ 85	°C

Electronics Characteristics (Ta=25°C, V_{IN}=V_{OUT}+1V, C_{IN}=C_{OUT}=4.7uF, unless otherwise noted)

Parameter	Symbol	Condition	Min.	Typ.	Max.	Unit
Output Voltage	V _{OUT}	V _{OUT} < 1.5V, V _{IN} =2.5V, I _{OUT} =1mA	V _{OUT} - 30mV	V _{OUT}	V _{OUT} + 30mV	V
		V _{OUT} ≥ 1.5V, I _{OUT} =1mA	V _{OUT} * 0.98	V _{OUT}	V _{OUT} * 1.02	
Dropout Voltage	V _{DROP}	V _{OUT} =V _{OUT} *0.98, I _{OUT} =1A		250	450	mV
Current Limit	I _{LIM}	V _{IN} =5V	1.2			A
Line Regulation	ΔV _{LINE}	V _{OUT} =3.3V, V _{IN} =4.3~6.0V, I _{OUT} =1mA		5	10	mV
Load Regulation	ΔV _{Load}	V _{OUT} =3.3V, I _{OUT} =1~800mA		10	30	mV
Quiescent Current	I _Q	V _{OUT} =3.3V, I _{OUT} =0		150	200	uA
Power Supply Ripple Rejection	PSRR	V _{IN} =(V _{OUT} +1V) _{DC} +0.2V _{P-P} F=1KHz, I _{OUT} =10mA		65		dB
		V _{IN} =(V _{OUT} +1V) _{DC} +0.2V _{P-P} F=10KHz, I _{OUT} =10mA		58		
Output noise voltage	e _{NO}	10Hz to 100KHz, C _{OUT} =4.7μF		100		μV _{P-P}
EN logic high voltage	V _{ENH}	V _{IN} =5.5V, I _{OUT} =1mA	1.2			V
EN logic low voltage	V _{ENL}	V _{IN} =5.5V, I _{OUT} =0mA			0.4	V
Thermal shutdown threshold	T _{SD}			165		°C
Thermal shutdown hysteresis	ΔT _{SD}			30		°C

Typical characteristics ($T_A=25^\circ\text{C}$, $V_{IN}=V_{OUT}+1\text{V}$, $C_{IN}=C_{OUT}=4.7\mu\text{F}$, unless otherwise noted)

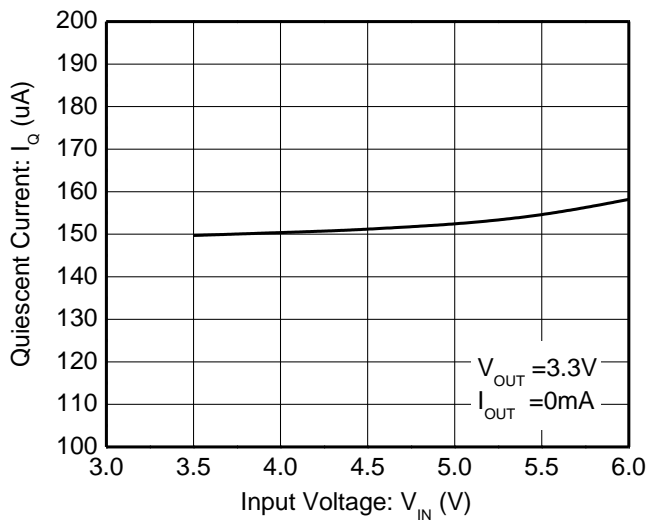

Quiescent current vs. Supply voltage

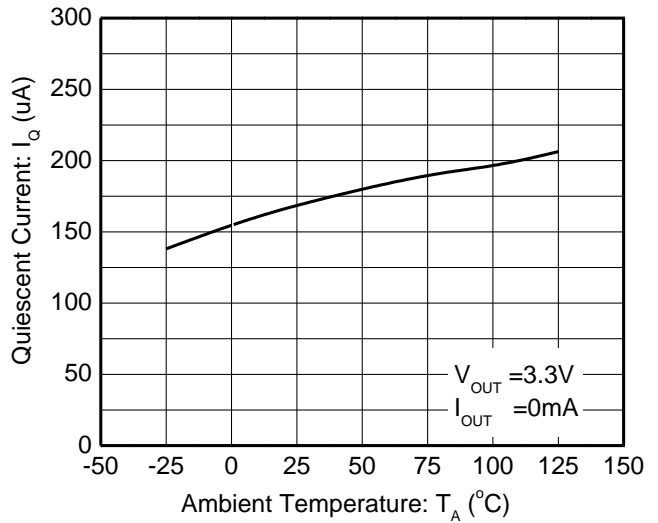

Quiescent current vs. Ambient temperature

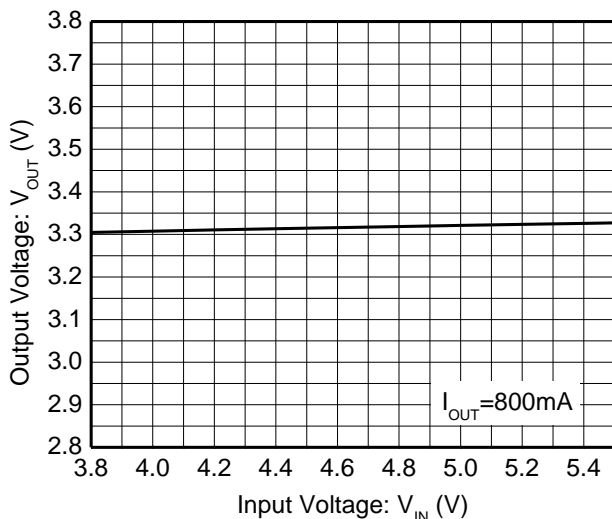

Output voltage vs. Supply voltage

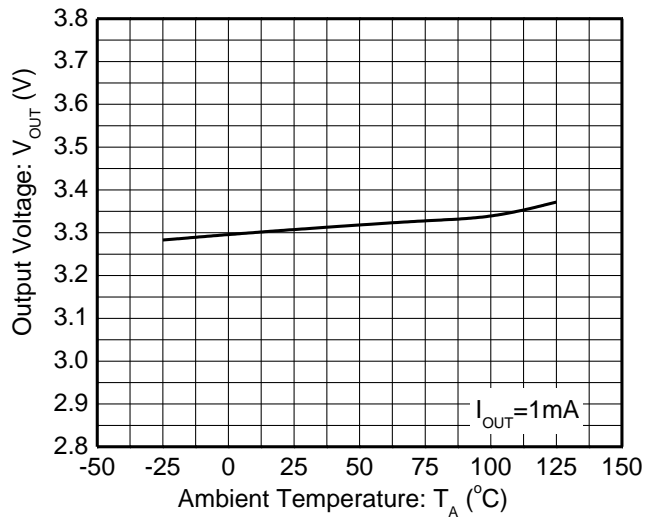

Output voltage vs. Ambient temperature

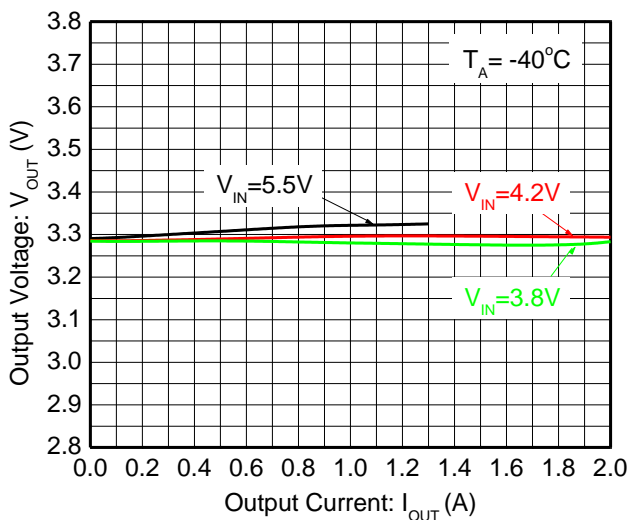

Output voltage vs. Output current

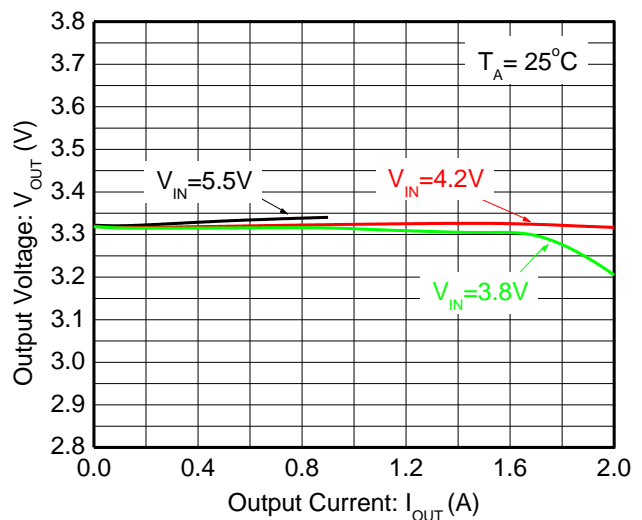

Output voltage vs. Output current

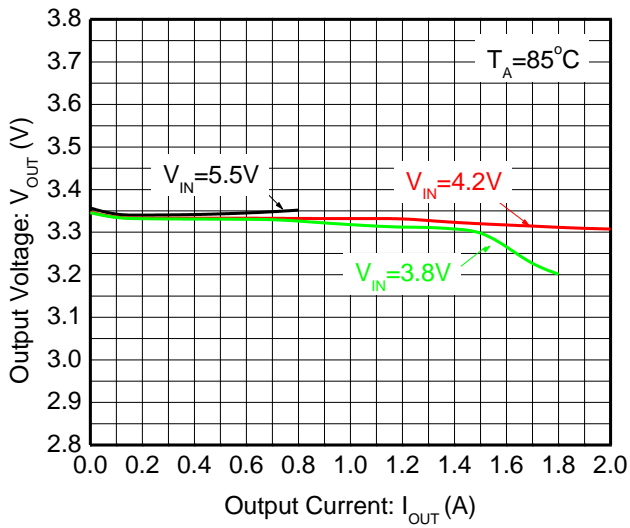

Output voltage vs. Output current

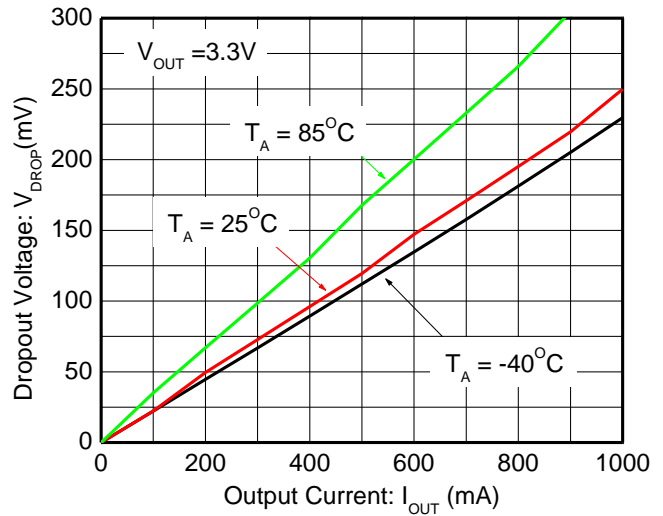

Dropout voltage vs. Output current

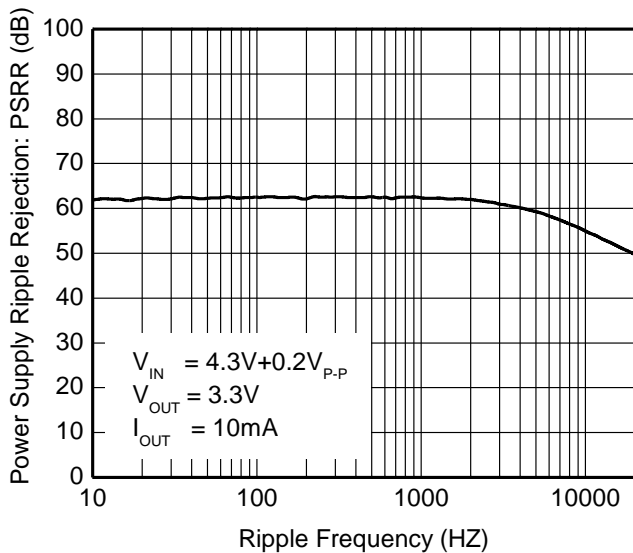

PSRR

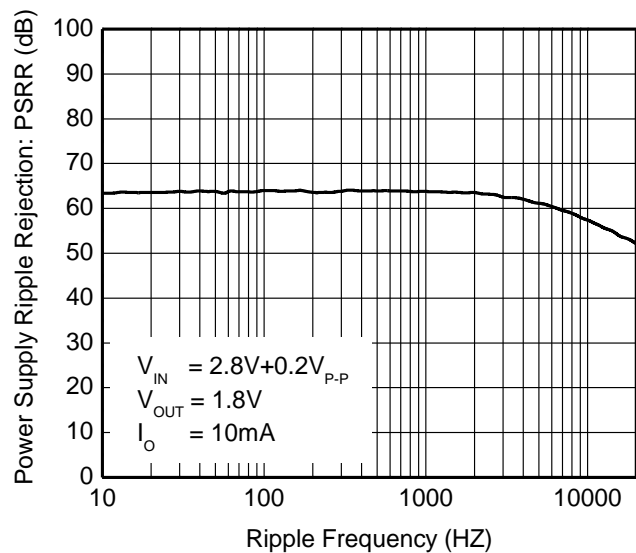

PSRR

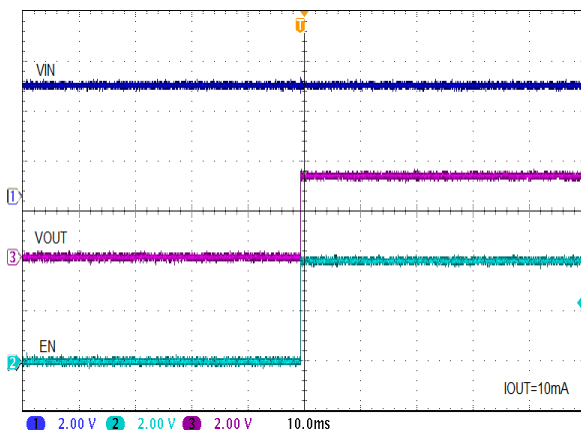

Startup with EN

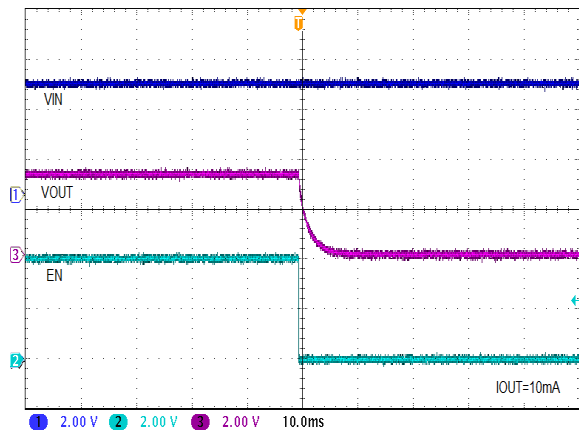

Shutdown with EN

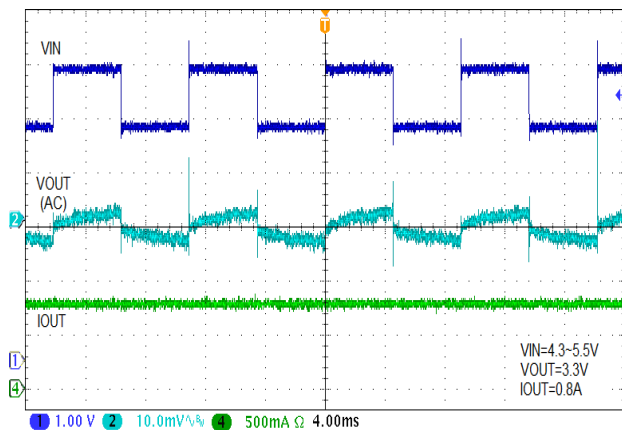

Line Regulation

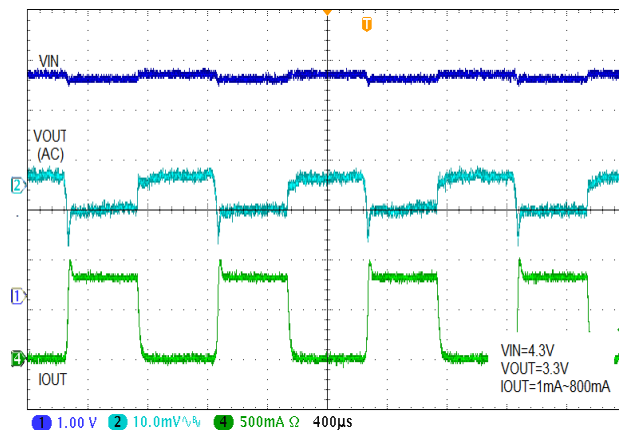

Load Regulation

Package outline dimensions

SOT-89-5L

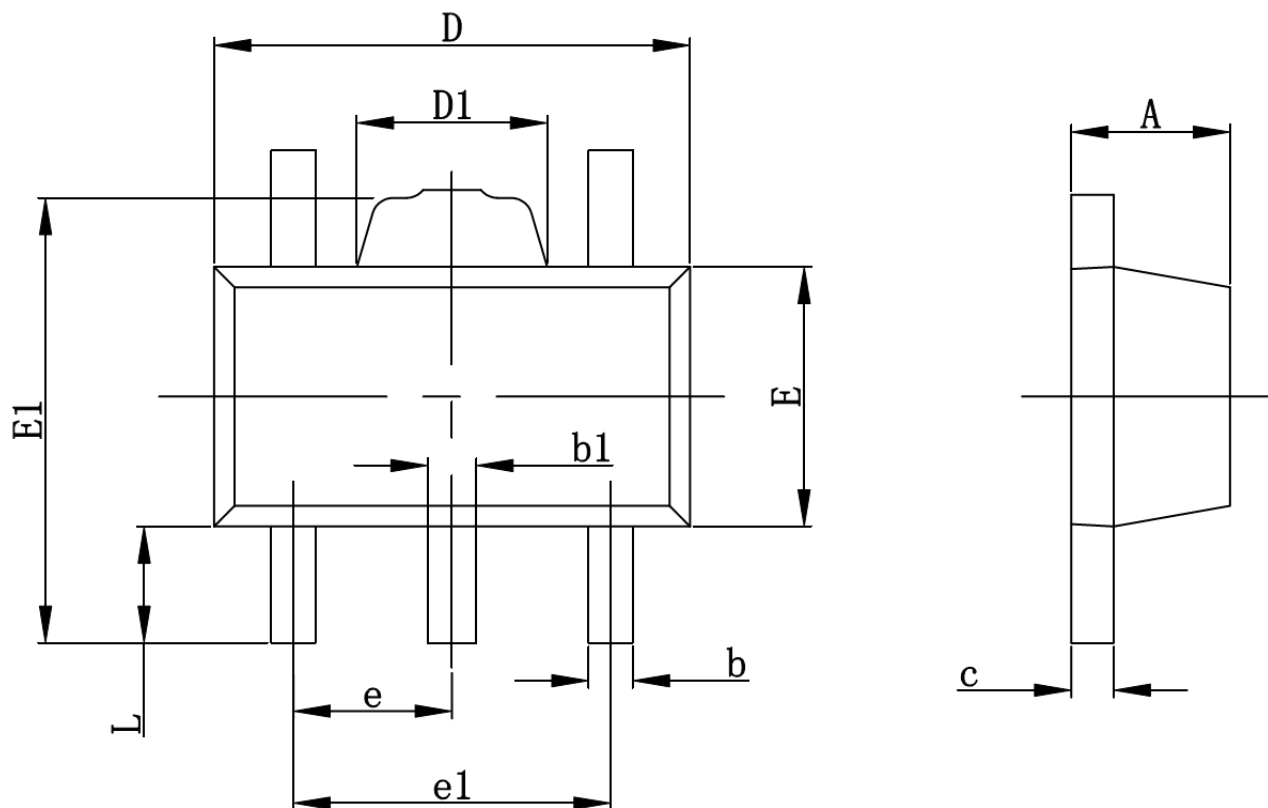

Symbol	Dimensions in millimeter		
	Min.	Typ.	Max.
A	1.400	1.500	1.600
b	0.320	0.420	0.520
b1	0.400	0.490	0.580
c	0.350	-	0.440
D	4.400	4.500	4.600
D1	1.550 Ref.		
E	2.300	2.450	2.600
E1	3.940	4.100	4.250
e	1.500 Typ.		
e1	3.000 Typ.		
L	0.900	-	1.200

**ORDER INFORMATION**

Ordering No.	V _{OUT} (V)	Package	Operating Temperature	Shipping
WL2803K18-5/TR	1.8	SOT-89-5L	-40 ~ +85°C	1000/Tape and Reel
WL2803K33-5/TR	3.3	SOT-89-5L	-40 ~ +85°C	1000/Tape and Reel